

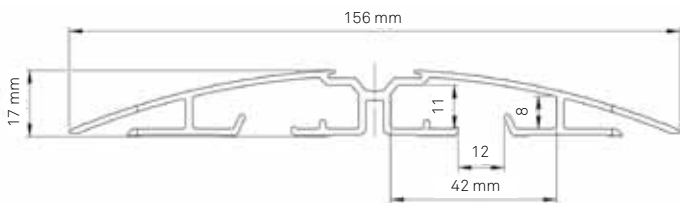

# Bridge







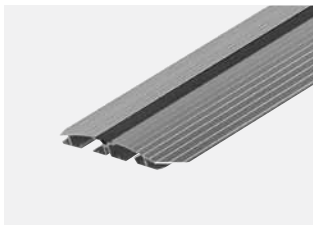





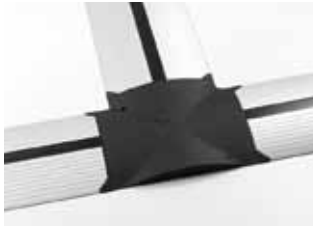

## Systematic Cable Organisation.

When power and data cables need to be distributed in a room, the EVoline® Bridge ensures the cables are systematically organised, for health and safety. The six EVoline® Bridge modules extend the Bridge profile range allowing cables to be distributed in nearly all directions. For example the vertical module delivers the possibility to make transitions from floor or ceilings to walls even to furniture. The specially designed adapter completes a flawless connection to our existing EVoline® WireLane System.

Description	Picture	Specification	Order No.
EVoline Bridge Screw mounted aluminium cable bridge (Screws are not supplied.) with black decoration insert		Length: 500 mm	1593 5010 5000
		Length: 800 mm	1593 5010 8000
		Length: 1.200 mm	1593 5011 2000
aluminium cable bridge with double sided tape with black decoration insert		Length: 500 mm	1593 5020 5000
		Length: 800 mm	1593 5020 8000
		Length: 1.200 mm	1593 5021 2000

For further lengths please consult our catalogue

# Bridge

Description	Picture	Specification	Order No.
Bridge Elbow Module 90°			1593 5090 0600
Bridge T-Module			1593 5090 0500
Bridge Cross Module			1593 5090 0200
Bridge Adapter Module also usable as termination piece			1593 5090 0100
Bridge Vertical Module			1593 5090 0400
Bridge Connectors			1593 5090 0300

**EVOLine<sup>®</sup>**  
ePlace Design

online   
undercover

Tietgensvej 16  
8600 Silkeborg  
Denmark

P: +45 21 62 54 68  
M: [info@onlineco.dk](mailto:info@onlineco.dk)  
W: [www.onlineco.dk](http://www.onlineco.dk)